

**DISTRICT X, SECTION 2-AA
FEBRUARY 18 and 19, 2022
@ SHARON HIGH SCHOOL
MEET DIRECTOR – ERIC MAUSSER**

PARTICIPATING SCHOOLS

REGION 1

**SLIPPERY ROCK
GROVE CITY
SHARON
MERCER
HICKORY
SHARPSVILLE**

REGION 2

**TITUSVILLE
FRANKLIN
CONNEAUT
COMMODORE PERRY
GREENVILLE
REYNOLDS**

**Tournament Schedule
Approximate Times**

Session One- Friday, February 18

I	4:00 pm	Weigh-ins
II	5:00	Coaches meeting
III	5:10	Anthem/Announcements
IV	5:15	Wrestling begins - Preliminaries
V	following IV	Quarterfinals
VI	following V	Consolation Preliminaries

Session Two- Saturday, February 19

I	8:00 am	Weigh-ins
II	9:00 am	Coaches meeting (If nec.)
III	9:15 am	Consolation Round 2
IV	following III	Semi-finals - Consolation Quarters
V	following IV	Consolation Semi-finals

Session Three- Saturday, February 19

I	3:30	3rd, 5th & 7th Place Matches
II	5:30	Parade of Champions
III	following II	Finals (1 mat)

10 Louie Gill 31-1

BYE

L. Gill
BYE
89

2022 PIAA AA D10 Section 2

AA

106

11 Lexi Doerflinger 17-10

10 Madilyn Enterline 11-5

21

9 Leyton Zacherl 17-6

10 Megan Barr 8-9

22

9 Brayden Ranalli 6-12

10 Cael Dailey 15-3

23

90

166

BYE

L

L21

L22

L23

91

L90

L89

138

139

163

L138

L139

164

L

L91

165

10 Carter Wise 19-5

BYE

C. Wise
BYE

92

11 Logan Hammerschmidt 9-10

10 Noah Christner 13-11

24

11 Hunter Giebel 17-8

BYE

H. Giebel
BYE

93

BYE

9 Dylan O'Brien 22-9

D. O'Brien
BYE

2022 PIAA AA D10 Section 2

AA

113

169

L BYE

L24

140

L BYE

L93

167

L BYE

BYE

L92

L140

168

L

L BYE

L BYE

2022 PIAA AA D10 Section 2

AA

120

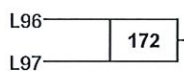
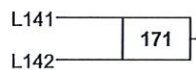
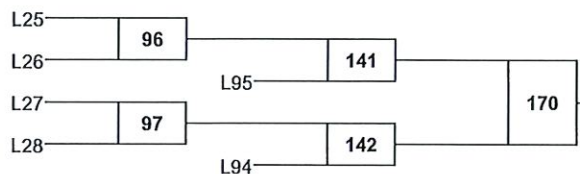
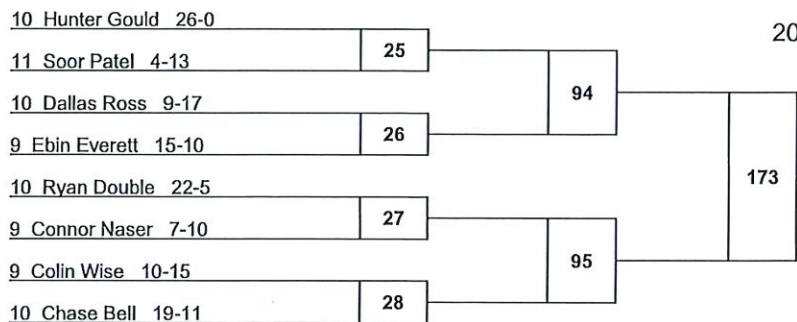

10 Alex Rueberger 20-7

BYE

9 Matt Knopp 5-15

10 Jordan Medve 5-13

10 Will Schell 10-5

11 Robbie Hetrick 2-5

BYE

10 Timmy Krivosh 16-8

10 Trenton Rodgers 19-9

BYE

10 Crue Etzel 1-12

12 Zane Lynch 15-9

11 Camden Reiser 10-8

10 Gage Gilmore 3-10

BYE

11 Braydon Porter 24-9

A. Rueberger
BYE

29

1

2

30

T. Krivosh
BYE

T. Rodgers
BYE

31

3

4

32

B. Porter
BYE

2022 PIAA AA D10 Section 2

AA

126

98

177

99

BYE

L1

L32

69

100

L2

BYE

L31

70

L98

143

L3

BYE

L30

71

101

174

L4

BYE

L29

72

L99

144

L143

175

L144

L100

176

L101

2022 PIAA AA D10 Section 2

AA
132

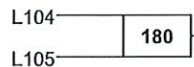
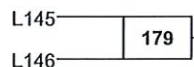
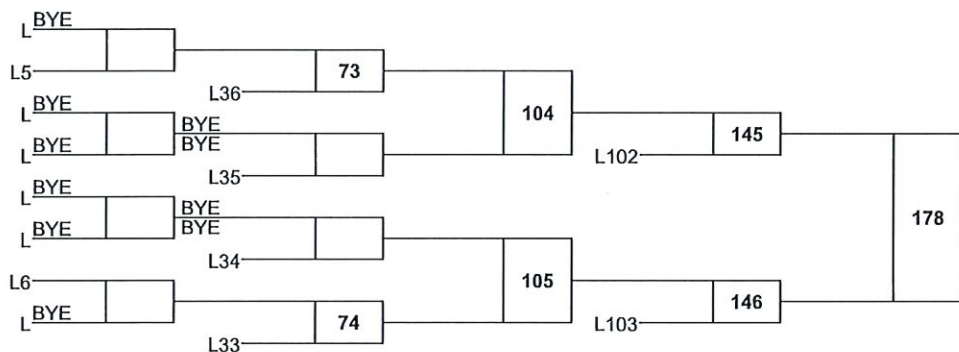
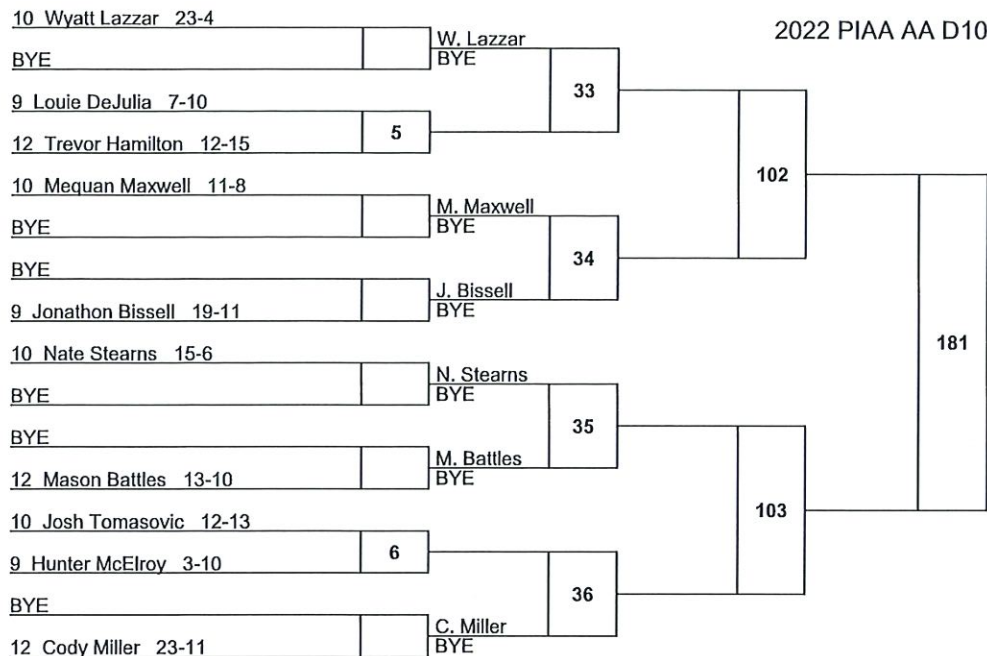

2022 PIAA AA D10 Section 2

AA
138

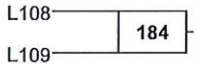
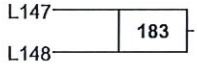
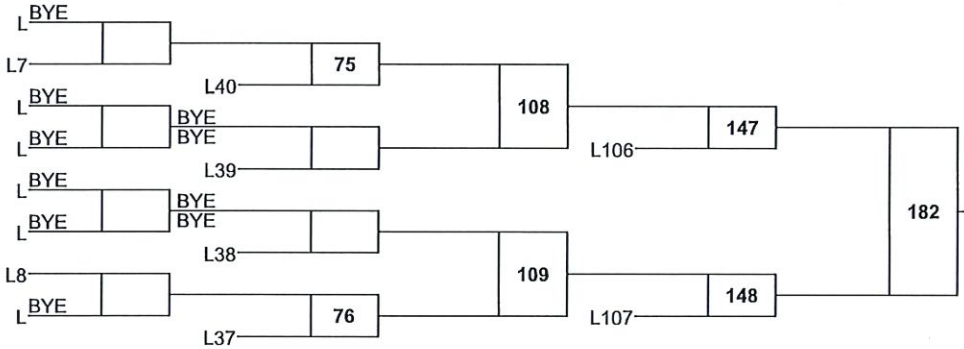
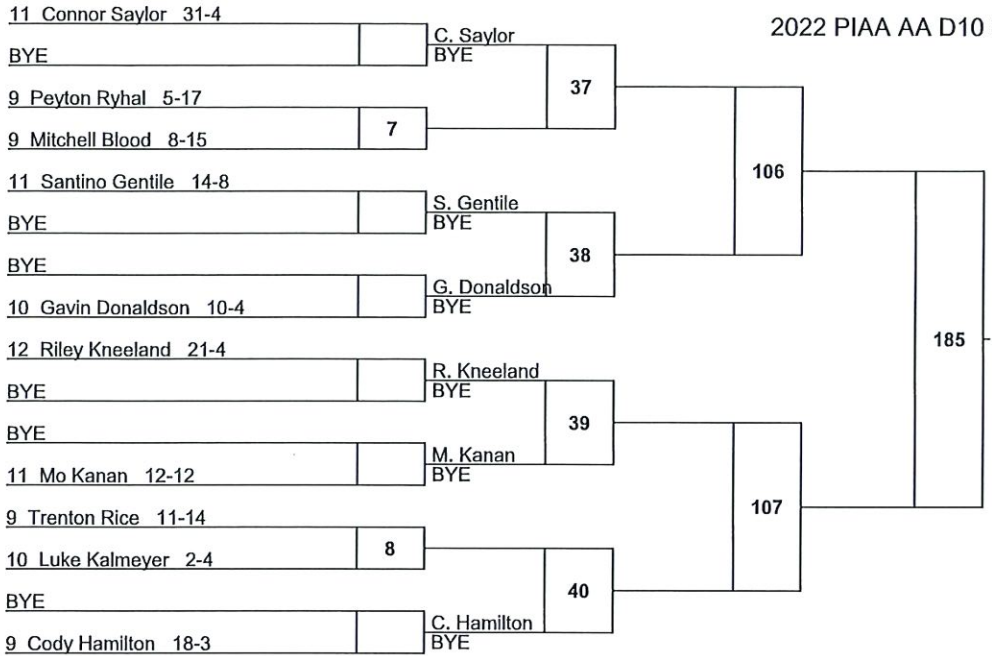

2022 PIAA AA D10 Section 2

AA
145

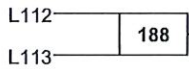
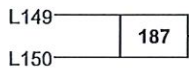
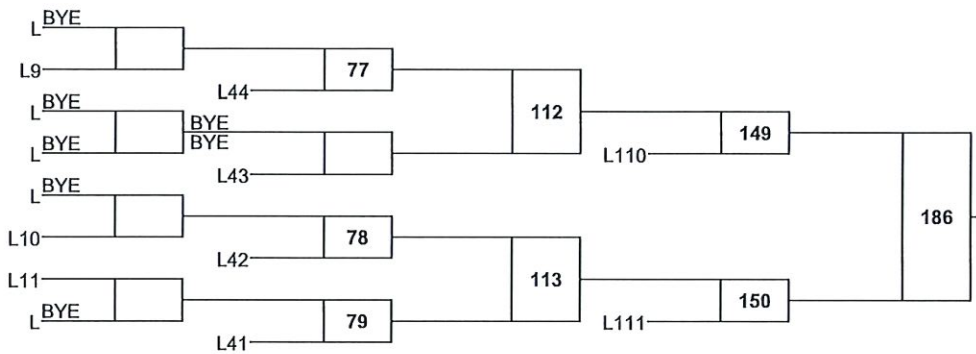
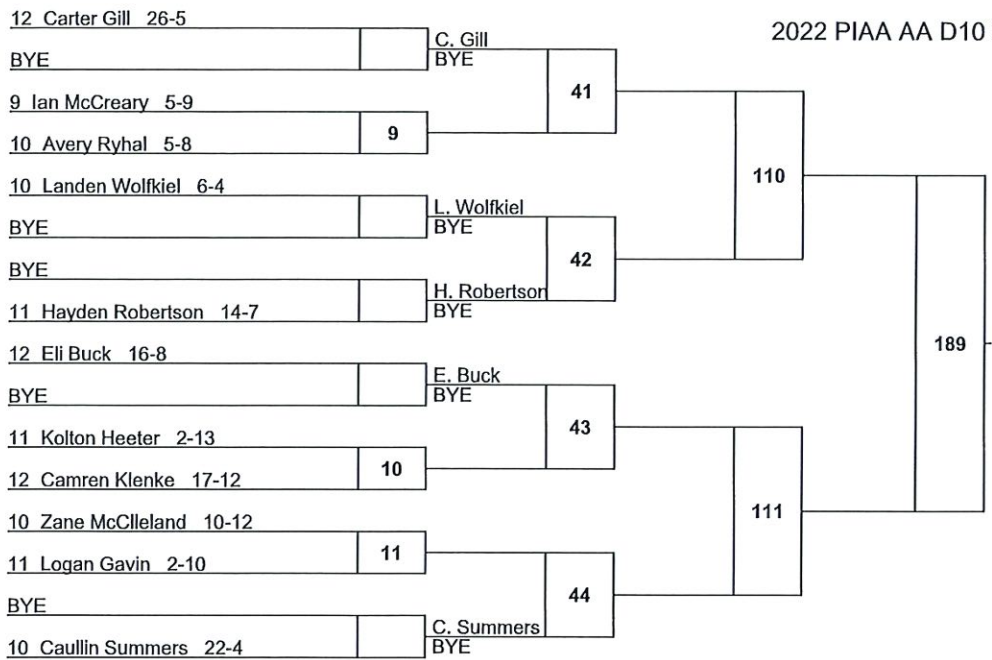

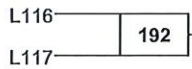
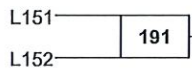
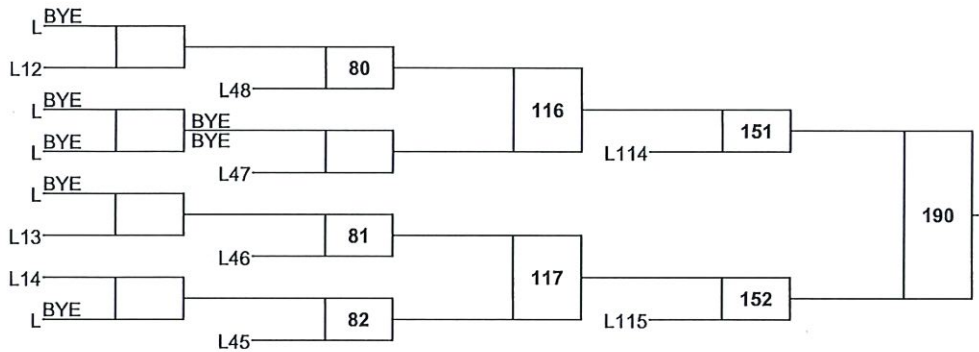
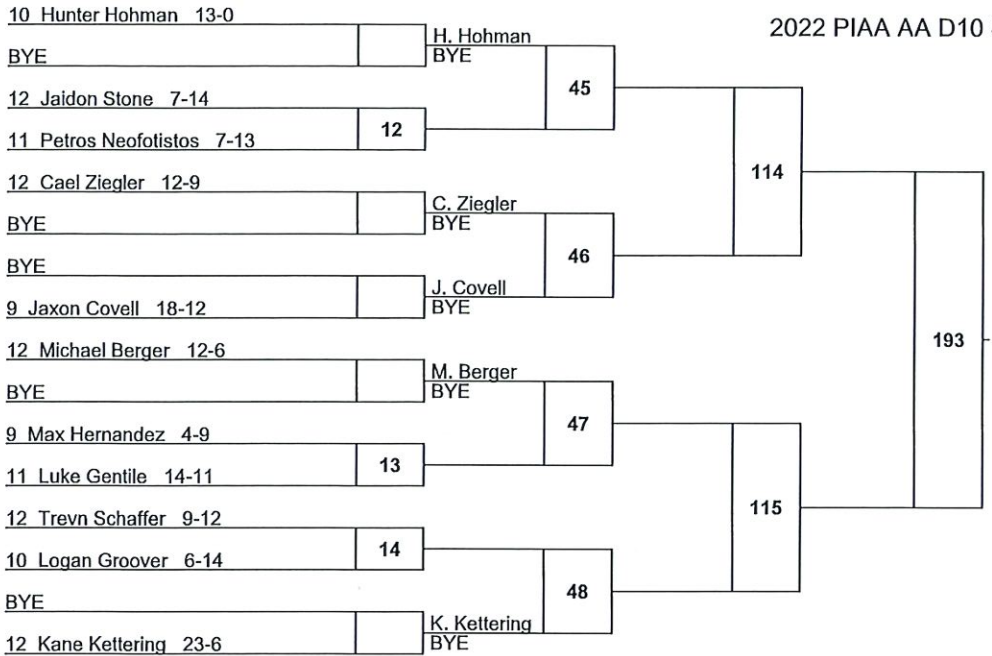

11 Collin Hearn 20-2

BYE

C. Hearn
BYE

49

11 Dylan Hunyadi 8-10

9 Alex Hackwelder 10-11

15

11 Jonah Heckathorne 18-12

BYE

J. Heckathorne
BYE

50

BYE

10 Mitchell Tingley 9-4

M. Tingley
BYE

11 Christian Hacker 21-6

BYE

C. Hacker
BYE

51

10 Nick Michaels 1-8

9 Vito Gentile 17-12

16

9 Klint Shamblin 7-6

12 Mason Moore 7-10

17

BYE

10 Josh Divens 21-8

J. Divens
BYE

52

2022 PIAA AA D10 Section 2

AA

160

118

197

119

BYE

L15

L52

83

120

BYE

BYE

BYE

L51

L118

153

194

L16

BYE

L50

84

121

L17

BYE

L49

85

L119

154

L153

195

L154

L120

196

L121

11 Jalen Wagner 22-6

BYE

J. Wagner
BYE

2022 PIAA AA D10 Section 2

AA
172

10 David Moyer 6-18

11 Muawiyah Maani 3-7

18

53

10 Nathan Stanton 12-5

BYE

N. Stanton
BYE

BYE

12 Justin Pearce 18-4

J. Pearce
BYE

54

11 Brock Covell 25-5

BYE

B. Covell
BYE

55

BYE

11 Ty Holland 24-12

T. Holland
BYE

56

10 Bennett Hayne 12-10

11 Hunter Marsteller 4-13

19

BYE

12 Clayton Smith 21-5

C. Smith
BYE

56

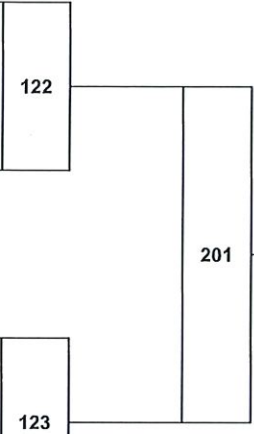

BYE

L18

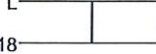

L56

86

BYE

BYE

BYE

BYE

L19

BYE

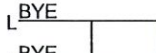

L55

124

BYE

BYE

BYE

BYE

L54

125

L53

87

L122

155

L123

156

198

L155

199

L156

L124

200

L125

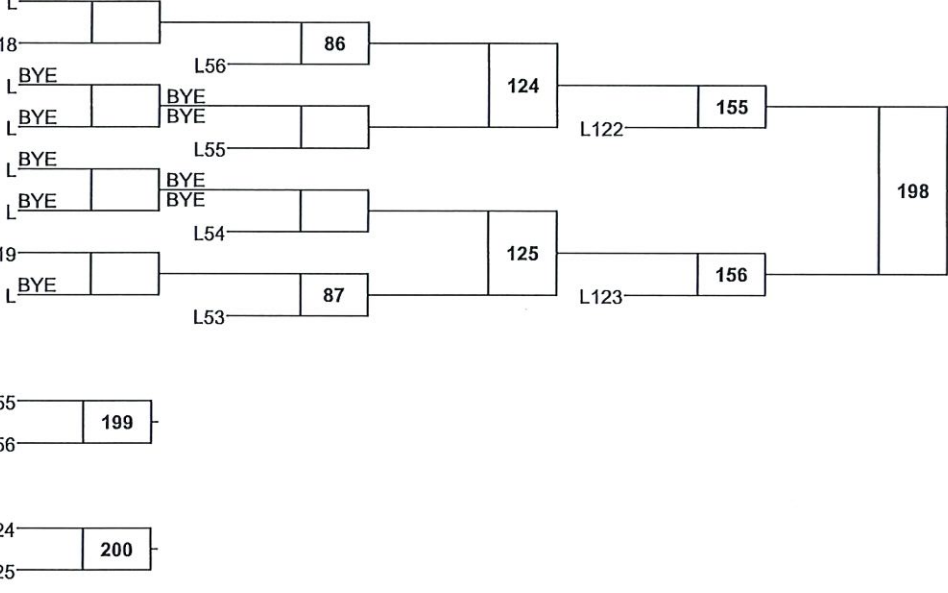

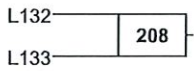
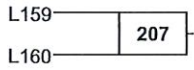
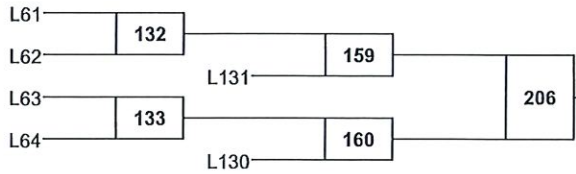
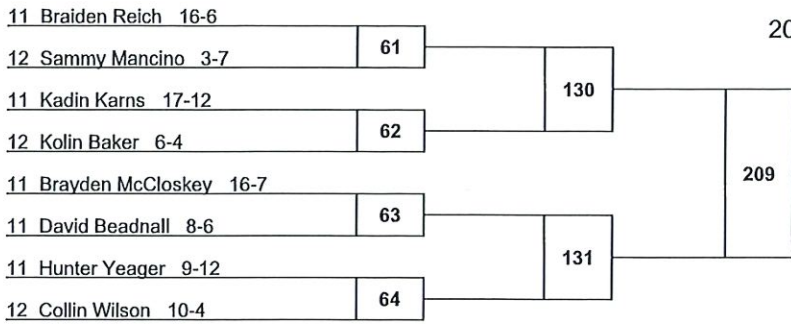

11 Mike Mazurek 23-3

10 Kolton Wilkinson 1-0

9 Garet Guthrie 6-8

12 Nick Maule 16-16

10 Malachi Hyde 8-7

9 Kanyon Crawford 5-11

10 Austin Mcfarland 4-15

12 Lodge Nosko 22-8

2022 PIAA AA D10 Section 2

AA

285

